

NOTES:

- 1.HOUSING: LCP HIGH-TEMP THERMOPLASTIC UL94V-0 COLOR:CREAM-COLOURED
- 2.TERMINAL:PHOSPHOR BRONZE
- 3.CODING INFORMATION: CY100-GxxP-COR

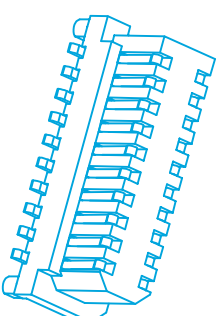

3D VIEW

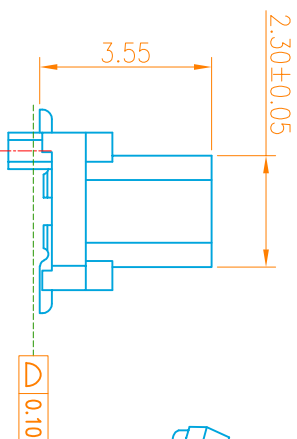
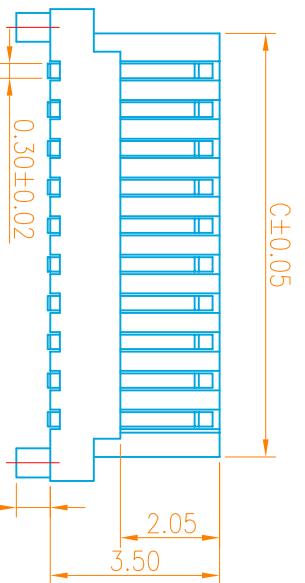
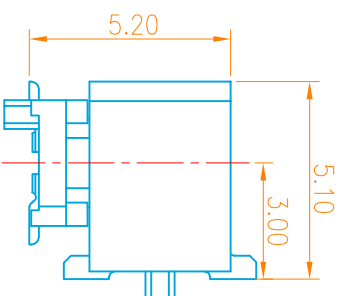
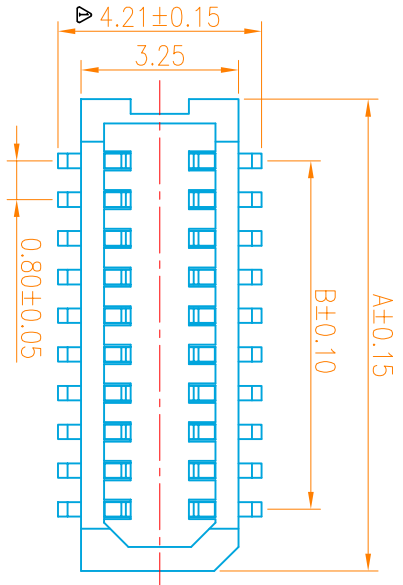
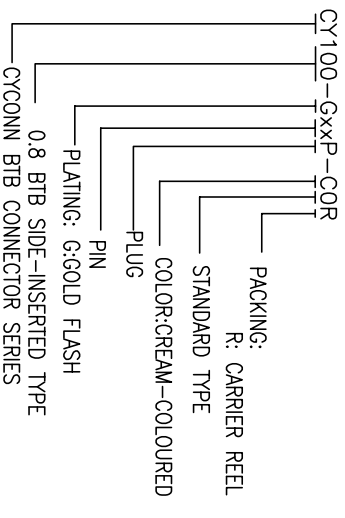
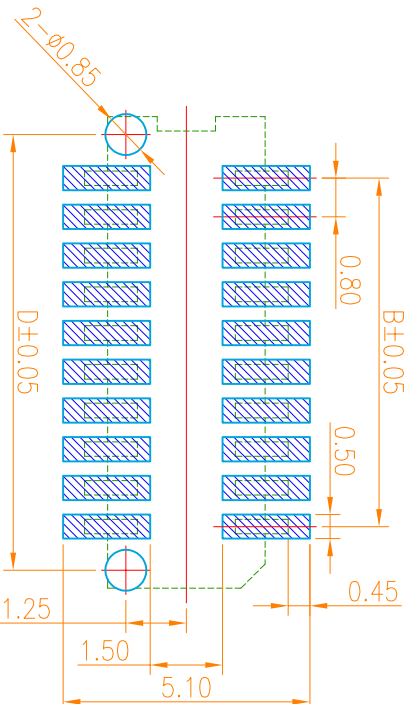
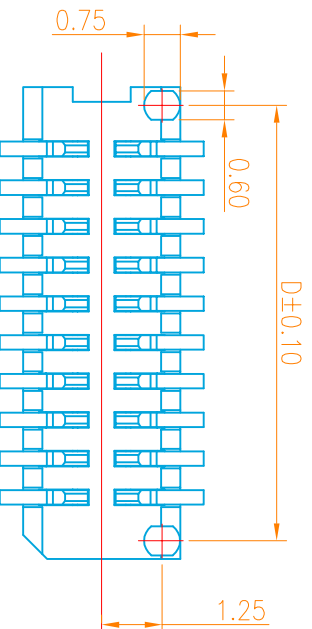

NO. of contacts	Dimensions			
	A.	B.	C.	D.
4	3.35	0.80	2.35	2.60
6	4.15	1.60	3.15	3.40
8	4.95	2.40	3.95	4.20
10	5.75	3.20	4.75	5.00
12	6.55	4.00	5.55	5.80
14	7.35	4.80	6.35	6.60
16	8.15	5.60	7.15	7.40
18	8.95	6.40	7.95	8.20
20	9.75	7.20	8.75	9.00
22	10.55	8.00	9.55	9.80
24	11.35	8.80	10.35	10.60
26	12.15	9.60	11.15	11.40
28	12.95	10.40	11.95	12.20
30	13.75	11.20	12.75	13.00
32	14.55	12.00	13.55	13.80
34	15.35	12.80	14.35	14.60
36	16.15	13.60	15.15	15.40
38	16.95	14.40	15.95	16.20
40	17.75	15.20	16.75	17.00
42	18.55	16.00	17.55	17.80
44	19.35	16.80	18.35	18.60
46	20.15	17.60	19.15	19.40
48	20.95	18.40	19.95	20.20
50	21.75	19.20	20.75	21.00
52	22.55	20.00	21.55	21.80

东莞市创亿科技有限公司  
DONGGUAN CYCONN TECHNOLOGY CO., LTD

ROHS Compliant  
2013/9/5/EC

1	2	3	4	5	6	7	8
<p>新增焊脚脚位尺寸</p>		<p>修改摘要</p>		<p>签名: Kevin</p>		<p>日期: 08/15/17</p>	
<p>修订 SDR</p>		<p>REVISION DESCRIPTION</p>		<p>版本: B</p>		<p>版本 (VER)</p>	

一般公差

±0.25

±0.15

±0.08

±0.05

制图 (DWG):

审核 (CHKD):

批准 (APP):

品名 (TITLE): 0.8mm 侧插B7B PLUG

料号 (PART NO.): CY100-GxxP-COR

比例 (SCALE): 1:8

单位 (UNITS): mm

张数 (SHEET): 1 OF 1

图幅 (SIZE): A4